

Pragmalux Sensus PIR sensor Zhaga 18 hoogmontage Casambi 0-10V

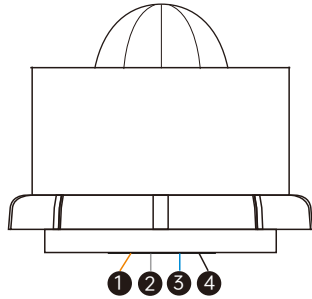

Important: Read All Instructions Prior to Installation

Function introduction



* Magnetic Reset

Zhaga Receptacle Accessory (optional for order)

- ① Port 1 (Brown): VCC (12-24V)
- ② Port 2 (Gray): GND/ Dim- (0-10V signal)
- ③ Port 3 (Blue): No connection
- ④ Port 4 (Black): DIM+ (0-10V signal)

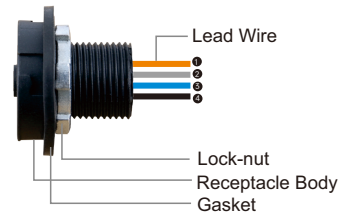

Product Description

The IP65 motion sensor combines presence sensing, daylight harvesting, 0-10V dimming and Casambi radio technology. The sensor can work with 0-10V dim-to-off LED drivers, and the luminaires just need to be connected to mains power. The result is increased occupant comfort and significant energy savings that meet the most demanding building energy codes.

Casambi Technology Explained

The Casambi technology provides a mesh network where all the intelligence of the system is replicated in every node and, in such a way, creates a system with no single point of failure. In this kind of fully distributed architecture, any unit can go offline and catch up from others when they return back online.

Wireless Features

- Control a large number of fixtures from any point
- Simple to use UI
- Wide range of functionality – Grouping Luminaires, different lighting situations for different occasions, colour temperature, daylight sensor, occupancy sensor and much more.

Key Features

- PIR motion detection
- Daylight harvesting
- Works with 0-10V dim-to-off drivers
- Autonomous sensor-based control
- Can be used for outdoor applications
- ZHAGA Book 18 socket

Benefits

- Cost-effective solution for energy savings
- Energy code compliance
- Robust mesh network

Applications

- Warehouses
- Factories
- Street and Area Lighting
- Outdoor Luminaires - Wall Packs - Parking Lots - Walkways
- Photo Controls
- Central Management System

Product Data

Electrical Information

Power Supply	12-24VDC
Current Consumption	< 20mA
Dimming Control	0-10V
Status Indicators	Red (motion detection)

Wireless Communication

Transceiver Frequency	2.4GHz ISM band
Radio Range	164 feet (50m) in open field
Radio Certification	FCC/IC, CE

Sensing

Occupancy Sensing Type	PIR sensor
Lux Detection Range	0-1000 Lux
Mounting Height	Up to 17m, recommended height: 12-15m
Detection Angle	360° (ceiling)
Detection Range	Up to 18 meters @ 17m installation height

Environment

Operating Temperature Range	-20°C~50°C / -68°F ~122°F
Operating Humidity	0-95% (non condensing)
Safety Certification	cULus Listed, CE

Wiring Diagram

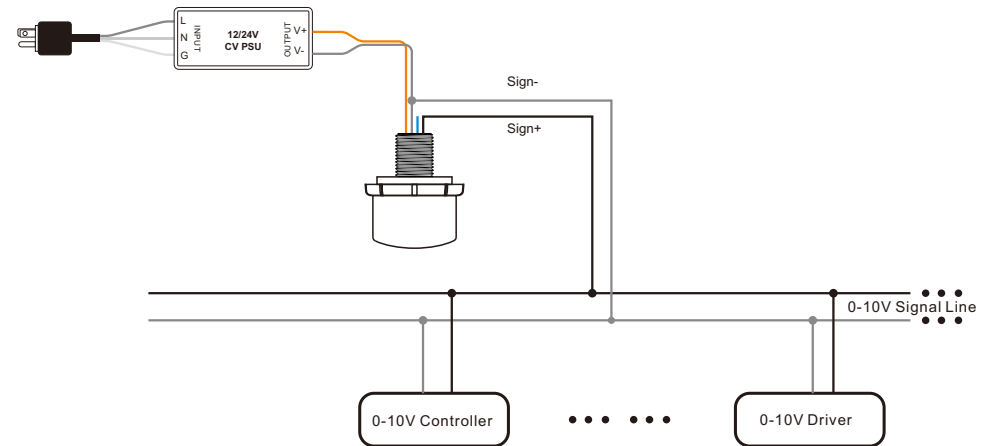

Note: please make sure the polarity of 0-10V signal of the sensor is correctly connected.

Detection Pattern

Coverage Side View

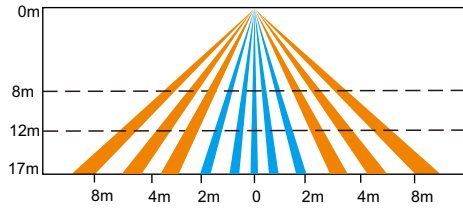

Coverage Top View

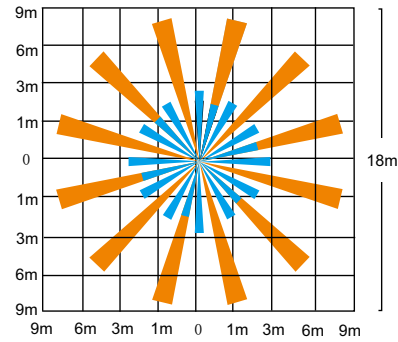

The detection area for movement sensor can be roughly divided into two parts:

- Slow movement (person moving < 1.0/s or 0.3m/s)
- Quick movement (person moving > 1.3/s or 0.4m/s)

Detection Area

Note:

- 1) Following different detection areas are based on different installation heights & patterns.
- 2) Detection Pattern is a relevant value, the performance should depends on the site conditions (installation height/ temperature/ humidity/ blind area...etc)

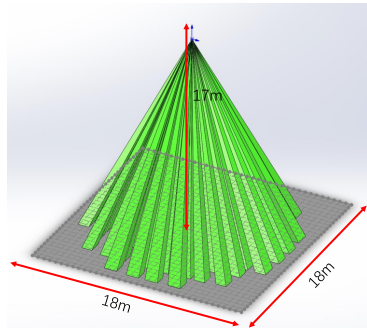

Detection pattern at 17m height

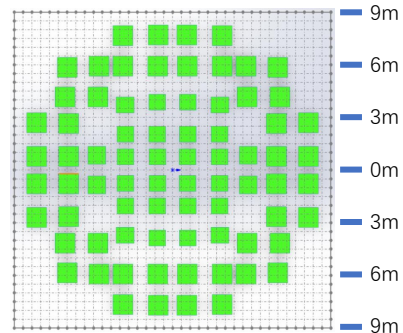

Detection pattern at 17m height

Product Dimension

